

MANUFACTURER <i>Produttore</i>	Phoenix Prime Focus, Italy	MODEL NO. <i>Model</i>	Flame Tree FT860
DESCRIPTION <i>Descrizione</i>	Rectangular Stone Hearth Oven <i>Forno rettangolare con platea in pietra refrattaria</i>		
PURPOSE <i>Scopo</i>	Multi-function stone hearth oven for cooking pizza, breads, meats and other dishes <i>Forno multifunzione con piano di cottura in pietra utilizzato per cuocere Pizza, Pane, Carne e altri piatti</i>		
FUEL OPTIONS <i>Opzioni di riscaldamento</i>	Solid fuel (wood fire) - Gas - Electric <i>Legna - Gas - Elettrico</i>	FUEL REQUIREMENTS <i>Requisiti per l'alimentazione</i>	Solid fuel (wood) <i>Legna</i>
GAS REQUIREMENTS <i>Requisiti per il Gas</i>	From/Da - 16.7Kw To/A 24.5 Kw Detailed indications in the attached drawing <i>Indicazioni dettagliate a disegno</i>	ELECTRICAL REQUIREMENTS <i>Requisiti Elettrici</i>	10.5Kw 3PH Detailed indications in the attached drawing <i>Indicazioni dettagliate a disegno</i>
EXHAUST REQUIREMENTS <i>Requisiti per scarico fumi</i>	Under Exhaust Canopy/Hood (by Others) or Direct connect via Phoenix water spray filter accessory or flue transition with particle filter and fitted with Thermal Interlock Sensor & Pressure Switch, to a grease rated exhaust fitted with a suitable power fan (duct & fan by Others). Note: the exhaust is best in a dedicated system. It is critical that ductwork be installed in accordance with local regulations. <i>Sotto ad una cappa (non inclusa) o con collegamneto diretto tramite Spray filter o scatola di transizione dotato di pressostato e termostato di sicurezza.</i> <i>Nota: Lo scarico dedicato è sempre la soluzione migliore. Fondamentale che i condotti di scarico siano dimensionati secondo le normative locali vigenti</i>		
EXTERNAL DIMENSIONS <i>Dimensioni esterne</i>	1200x1030x2220H (mm) Detailed indications in the attached drawing <i>Indicazioni dettagliate a disegno</i>	INTERNAL DIMENSIONS <i>Dimensioni interne</i>	860x690x370/430H (mm) Detailed indications in the attached drawing <i>Indicazioni dettagliate a disegno</i>
MEP RATINGS <i>Connessioni</i>	Detailed indications in the attached drawing <i>Indicazioni dettagliate a disegno</i>	WEIGHT <i>Peso</i>	950Kg - approx
COMPLIANCE <i>Conformità</i>	The oven and gas system are CE rated, all electric systems are CE compliant. <i>Il forno e l'impianto a gas sono certificati CE, tutti gli impianti elettrici sono a norma CE.</i>		
SAFETY NOTES <i>Aspetti di sicurezza</i>	The oven must be vented in accordance with local and/or national codes. All gas systems fitted with flame failure, thermal interlock sensor and pressure differential switch for safety. Oven façade/enclosure is to be constructed from fire-rated, non-combustible materials. Access panels required above and below (ventilated) the oven (min size 600x600mm). The temperature outside the insulation is below 40 °C to ensure proper installation of the cladding. <i>Il forno deve essere ventilato secondo le normative locali. Tutti gli impianti a gas sono dotati di pressostato e termostato di sicurezza. Il rivestimento del forno deve essere costruito con materiali ignifughi e non combustibili. Sono necessari pannelli di accesso sopra e sotto (ventilato) il forno (dim. minime 600x600mm).</i> <i>La temperatura esterna all'isolante è al di sotto dei 40°C per garantire una corretta installazione del rivestimento.</i>		
MANUFACTURER MATERIALS <i>Materiali costruttivi</i>	High quality ceramic materials fully enclosed in a 5mm mild steel external shell. One piece cast ceramic ceiling. The cooking surface is constructed using high quality ceramic alumina bricks. Fold down door with thermal glass. <i>La volta è realizzata con materiale refrattario di alta qualità racchiuso in un guscio di ferro di 5mm.</i> <i>La platea è realizzata con mattoni ad alto contenuto di allumina. Anta a ribalta con vetro per alte temperature.</i>		
WARRANTY <i>Garanzia</i>	4 Year Structural Guarantee, 12 Months for Gas/Electric System & Components <i>4 anni di garanzia sulla struttura, 12 mesi su tutti i componenti.</i>		

STANDARD FEATURES & OPTIONS

- Thermostatically controlled gas system with display gas burner for aesthetic quality.
- Electrical system optimized to provide maximum heat distribution over the entire floor.
- Unique exhaust design with advanced safety features.
- Easy digital touch control panel with intuitive display, discretely concealed within front lintel panel for operator convenience.
- One piece SS hearth and lintel surround for oven mouth allows for easy and safe integration with architectural façade.
- Flame resistant particle filter, easily accessibly for regular cleaning and maintenance from front of the oven.
- Internal spotlight included in all ovens.

OPTIONS:

- viewing window, char grill, wood storage trolley, custom cladding
- Only for electric oven: Vapor display feature with / without external view window.

CARATTERISTICHE & OPZIONI

- Impianto a gas termostato con bruciatore ad alto effetto visivo.
- Impianto elettrico ottimizzato per fornire la massima distribuzione del calore su tutta la platea
- Design unico dello scarico fumi con sistema di sicurezza avanzato.
- Pannello di controllo digitale con display intuitivo, integrato sul lato frontale del Lintel.
- La volta in pezzo unico e il lintel in acciaio consentono un'integrazione facile e sicura con il rivestimento.
- Filtro frontale di facile accesso per la pulizia giornaliera.
- Faretto alogeno interno su tutti i modelli.
- OPZIONI: Visiva, Griglia gas, Griglia elettrica, Carrello porta legna, Cladding sartoriale, Set pale

EST. PIZZA OUTPUT (based on oven operating at 325° C)
Stima quantità di pizze prodotte (Temperatura forno 325°)



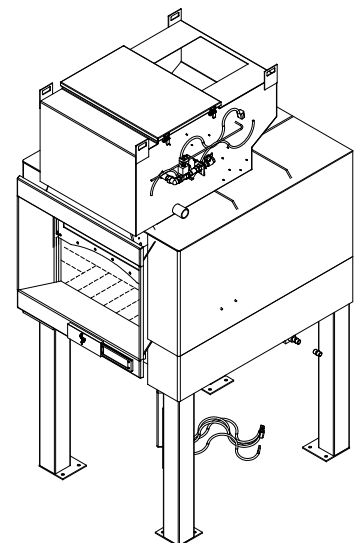

20cm/8"	24cm/10"	30cm/12"	40cm/16"
48/hr	35/hr	24/hr	10/hr



The image refers to the oven with the Spray Filter system installed.
L'immagine si riferisce al forno con il sistema Spray filter installato

Custom sizes available on request
Dimensioni su misura - Sempre disponibili

- Services -

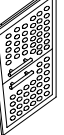
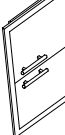
G-01	 NG - Natural Gas - G20/G25/G25.3 17/24 KW - 58004/81888 BTU/H 1/2" Inlet LPG - G30/G31 - 17/23 KW - 58004/78476 BTU/H 1/2" Inlet TOWN GAS - G110 - 17/22 KW - 58004/75064 BTU/H 1/2" Inlet
E-01	 Electric connection: 0.5 Kw - 230 V - 1PH 16 Amp
W-02	 Water connection Drain water connection 1 1/4" Copper or S/S to kitchen waste / tundish 32L/h - Consumption
W-01	 Water connection Cold water connection for spray filter 1/2"
Ex-01	 Exhaust connection: 300x300 mm Universal flange 450t/sec - @750Pa
P-02	 Panel requirements: 1x lower panel under oven - this must be ventilated - min. size 600x600 mm
P-01	 Panel requirements: On upper right side next to the spray filter min. size 600x600 mm

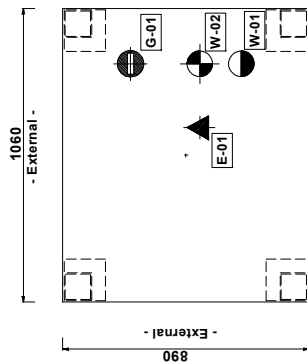

- Suggested M&E position -

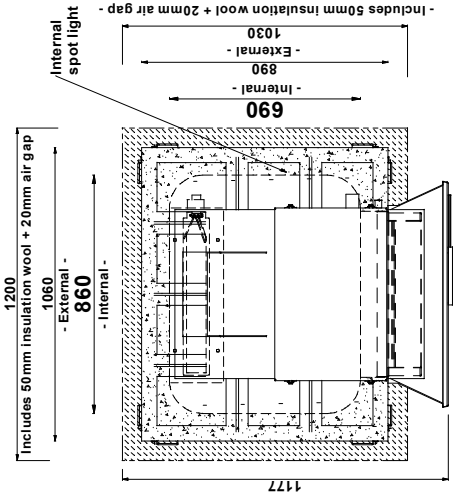
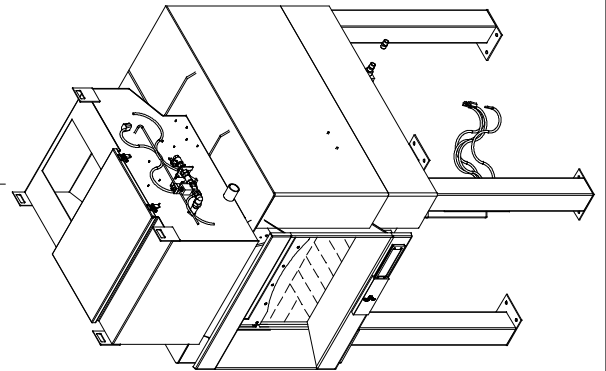
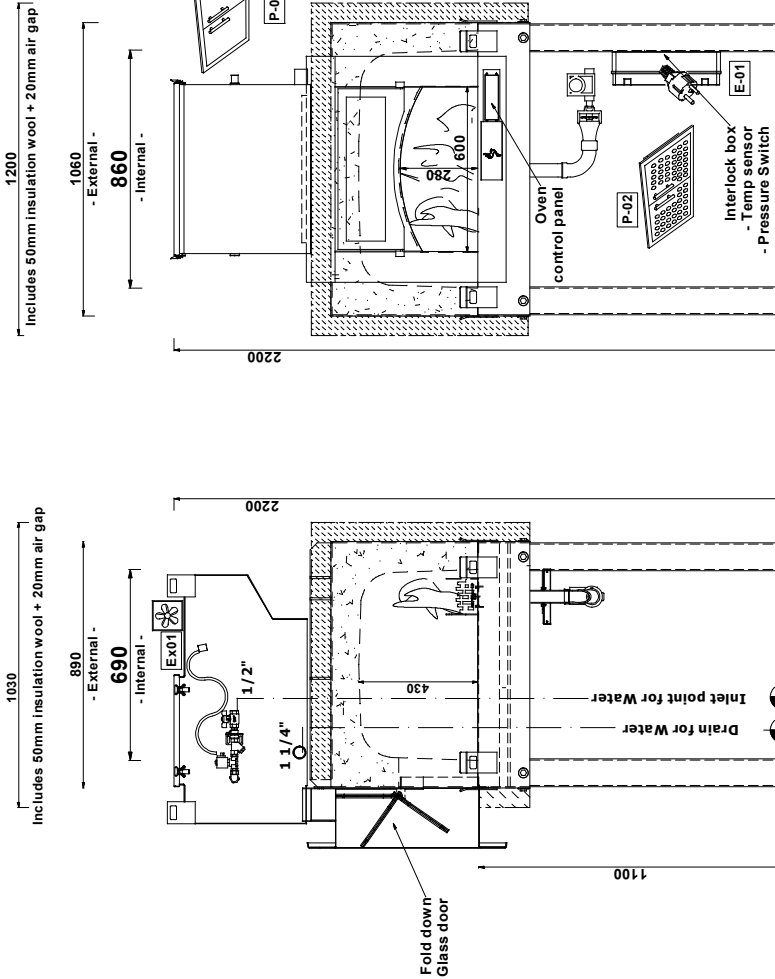

- Custom sizes available on request -

- Services -

NG - Natural Gas
- G20/G25/G25.3 -
17/24 KW - 58004/81888 BTU/H
1/2" Inlet



G-01

LPG
- G30/G31 -
17/23 KW - 58004/78476 BTU/H
1/2" Inlet



E-01

Electric connection:
0.5 Kw - 230 V - 1PH
16 Amp



Ex-01

Exhaust connection:
300x300 mm Universal flange
450lt/sec

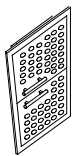

P-02

Panel requirements:
1x lower panel under oven
- this must be ventilated -
min. size 600x600 mm

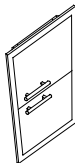

P-01

Panel requirements:
On upper right side
next to the spray filter
min. size 600x600 mm

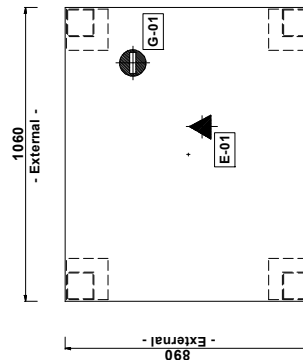

- Suggested M&E position -

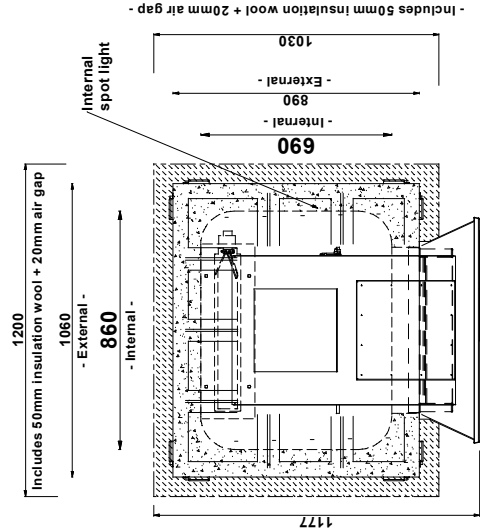
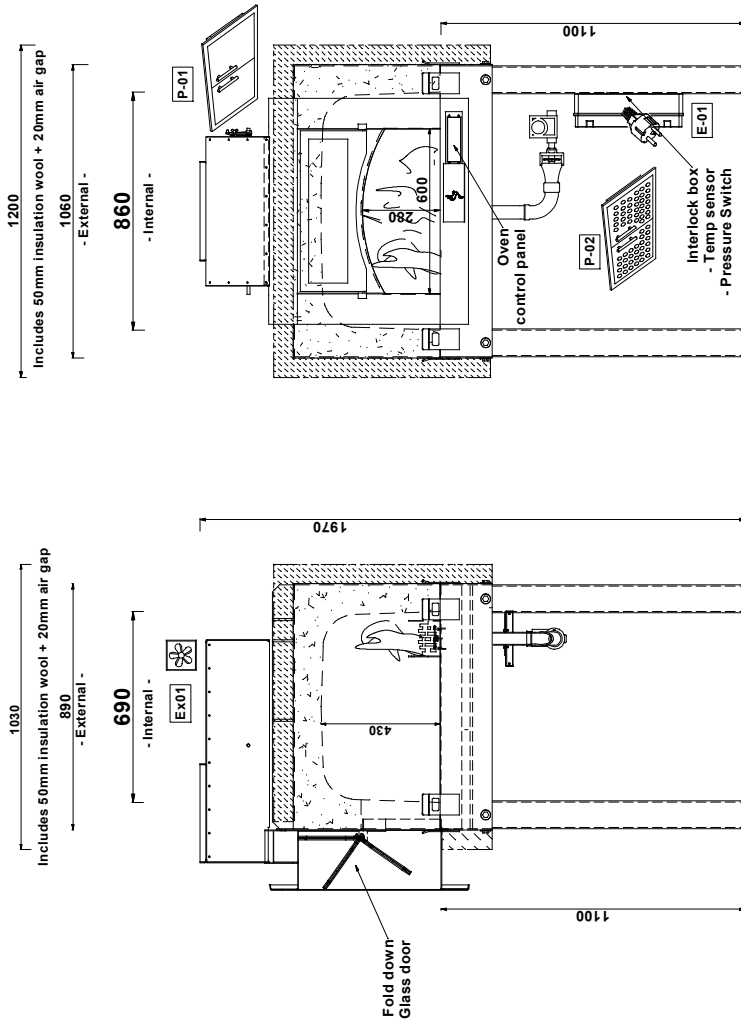

- Custom sizes available on request -

- Services -

NG - Natural Gas
- G20/G25/G25.3.
17/24 KW - 58004/81888 BTU/H
1/2" Inlet



G-01

LPG
- G30/G31 -
17/23 KW - 58004/78476 BTU/H
1/2" Inlet

TOWN GAS
- G110 -
17/22 KW - 58004/75064 BTU/H
1/2" Inlet

Electric connection:
0.5 Kw - 230 V - 1PH
16 Amp



E-01

Exhaust connection:
Canopy / Hood B Y Others



Ex-01

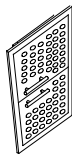

P-02

Panel requirements:
1x lower panel under oven
- this must be ventilated -
min. size 600x600 mm

1030
Includes 50mm insulation wool + 20mm air gap
- External -
890

690
- Internal -

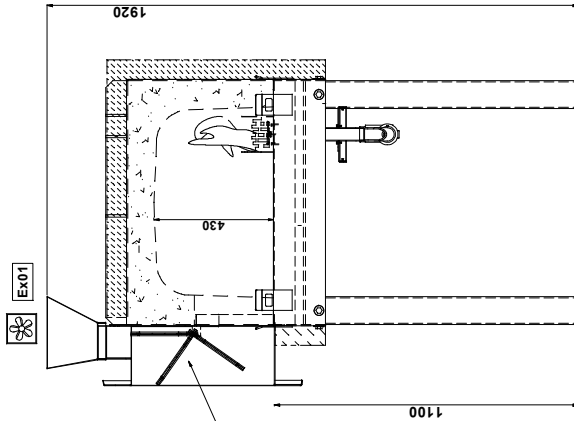

1200
Includes 50mm insulation wool + 20mm air gap
- External -
1060

860
- Internal -

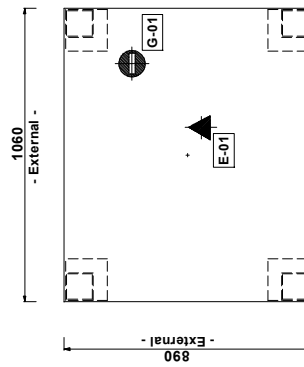
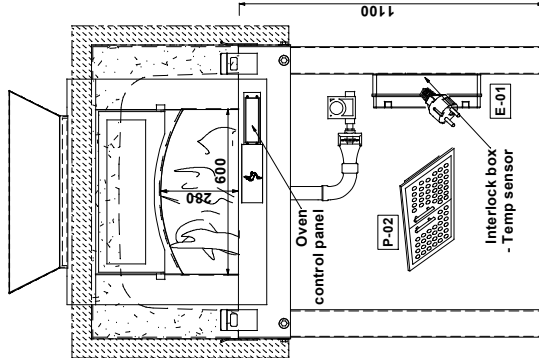

- Suggested M&E position -

1200
Includes 50mm insulation wool + 20mm air gap
- External -
1060

860
- Internal -

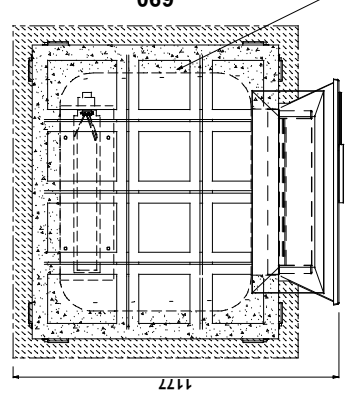

- Includes 50mm insulation wool + 20mm air gap -

- Custom sizes available on request -

