

<b>MANUFACTURER</b> <i>Produttore</i>	Phoenix Prime Focus, Italy	<b>MODEL NO.</b> <i>Model</i>	Flame Tree FT1500
<b>DESCRIPTION</b> <i>Descrizione</i>	Rectangular Stone Hearth Oven <i>Forno rettangolare con platea in pietra refrattaria</i>		
<b>PURPOSE</b> <i>Scopo</i>	Multi-function stone hearth oven for cooking pizza, breads, meats and other dishes <i>Forno multifunzione con piano di cottura in pietra utilizzato per cuocere Pizza, Pane, Carne e altri piatti</i>		
<b>FUEL OPTIONS</b> <i>Opzioni di riscaldamento</i>	Solid fuel ( wood fire ) - Gas - Electric <i>Legna - Gas - Elettrico</i>	<b>FUEL REQUIREMENTS</b> <i>Requisiti per l'alimentazione</i>	Solid fuel ( wood ) <i>Legna</i>
<b>GAS REQUIREMENTS</b> <i>Requisiti per il Gas</i>	From/Da - 25Kw To/A 35Kw Detailed indications in the attached drawing <i>Indicazioni dettagliate a disegno</i>	<b>ELECTRICAL REQUIREMENTS</b> <i>Requisiti Elettrici</i>	15.5Kw 3PH Detailed indications in the attached drawing <i>Indicazioni dettagliate a disegno</i>
<b>EXHAUST REQUIREMENTS</b> <i>Requisiti per scarico fumi</i>	Under Exhaust Canopy/Hood ( by Others ) or Direct connect via Phoenix water spray filter accessory or flue transition with particle filter and fitted with Thermal Interlock Sensor & Pressure Switch, to a grease rated exhaust fitted with a suitable power fan ( duct & fan by Others ). Note: the exhaust is best in a dedicated system. It is critical that ductwork be installed in accordance with local regulations. <i>Sotto ad una cappa ( non inclusa ) o con collegamneto diretto tramite Spray filter o scatola di transizione dotato di pressostato e termostato di sicurezza.</i> <i>Nota: Lo scarico dedicato è sempre la soluzione migliore. Fondamentale che i condotti di scarico siano dimensionati secondo le normative locali vigenti</i>		
<b>EXTERNAL DIMENSIONS</b> <i>Dimensioni esterne</i>	1840x1205x2220H (mm) Detailed indications in the attached drawing <i>Indicazioni dettagliate a disegno</i>	<b>INTERNAL DIMENSIONS</b> <i>Dimensioni interne</i>	1500x865x370/430H (mm) Detailed indications in the attached drawing <i>Indicazioni dettagliate a disegno</i>
<b>MEP RATINGS</b> <i>Connessioni</i>	Detailed indications in the attached drawing <i>Indicazioni dettagliate a disegno</i>	<b>WEIGHT</b> <i>Peso</i>	2050Kg - approx
<b>COMPLIANCE</b> <i>Conformità</i>	The oven and gas system are CE rated, all electric systems are CE compliant. <i>Il forno e l'impianto a gas sono certificati CE, tutti gli impianti elettrici sono a norma CE.</i>		
<b>SAFETY NOTES</b> <i>Aspetti di sicurezza</i>	The oven must be vented in accordance with local and/or national codes. All gas systems fitted with flame failure, thermal interlock sensor and pressure differential switch for safety. Oven façade/enclosure is to be constructed from fire-rated, non-combustible materials. Access panels required above and below (ventilated) the oven (min size 600x600mm). The temperature outside the insulation is below 40 °C to ensure proper installation of the cladding. <i>Il forno deve essere ventilato secondo le normative locali. Tutti gli impianti a gas sono dotati di pressostato e termostato di sicurezza. Il rivestimento del forno deve essere costruito con materiali ignifughi e non combustibili. Sono necessari pannelli di accesso sopra e sotto ( ventilato ) il forno ( dim. minime 600x600mm ).</i> <i>La temperatura esterna all'isolante è al di sotto dei 40°C per garantire una corretta installazione del rivestimento.</i>		
<b>MANUFACTURER MATERIALS</b> <i>Materiali costruttivi</i>	High quality ceramic materials fully enclosed in a 5mm mild steel external shell. One piece cast ceramic ceiling. The cooking surface is constructed using high quality ceramic alumina bricks. Fold down door with thermal glass. <i>La volta è realizzata con materiale refrattario di alta qualità racchiuso in un guscio di ferro di 5mm.</i> <i>La platea è realizzata con mattoni ad alto contenuto di allumina. Anta a ribalta con vetro per alte temperature.</i>		
<b>WARRANTY</b> <i>Garanzia</i>	4 Year Structural Guarantee, 12 Months for Gas/Electric System & Components <i>4 anni di garanzia sulla struttura, 12 mesi su tutti i componenti.</i>		

**STANDARD FEATURES & OPTIONS**

- Thermostatically controlled gas system with display gas burner for aesthetic quality.
- Electrical system optimized to provide maximum heat distribution over the entire floor.
- Unique exhaust design with advanced safety features.
- Easy digital touch control panel with intuitive display, discretely concealed within front lintel panel for operator convenience.
- One piece SS hearth and lintel surround for oven mouth allows for easy and safe integration with architectural façade.
- Flame resistant particle filter, easily accessible for regular cleaning and maintenance from front of the oven.
- Internal spotlight included in all ovens.

**OPTIONS:**

- viewing window, char grill, wood storage trolley, custom cladding
- Only for electric oven: Vapor display feature with / without external view window.

**CARATTERISTICHE & OPZIONI**

- Impianto a gas termostato con bruciatore ad alto effetto visivo.
- Impianto elettrico ottimizzato per fornire la massima distribuzione del calore su tutta la platea
- Design unico dello scarico fumi con sistema di sicurezza avanzato.
- Pannello di controllo digitale con display intuitivo, integrato sul lato frontale del Lintel.
- La volta in pezzo unico e il lintel in acciaio consentono un'integrazione facile e sicura con il rivestimento.
- Filtro frontale di facile accesso per la pulizia giornaliera.
- Faretto alogeno interno su tutti i modelli.
- OPZIONI: Visiva, Griglia gas, Griglia elettrica, Carrello porta legna, Cladding sartoriale, Set pale

EST. PIZZA OUTPUT (based on oven operating at 325° C)  
Stima quantità di pizze prodotte ( Temperatura forno 325° )

20cm/8"	24cm/10"	30cm/12"	40cm/16"
125/hr	98/hr	48/hr	35/hr

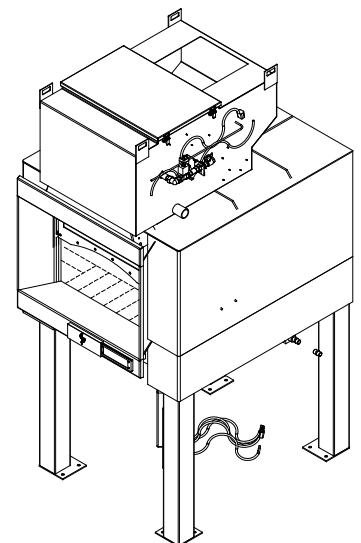

The image refers to the oven with the Spray Filter system installed.  
*L'immagine si riferisce al forno con il sistema Spray filter installato*

Custom sizes available on request  
*Dimensioni su misura - Sempre disponibili*

- Services -

NG - Natural Gas  
G300  
33035 KW - 112.866/119420 BTU/H  
1/2" Inlet



G-01

LPG  
- G300G31 -  
2932 KW - 99.948/109.184 BTU/H  
1/2" Inlet



TOWN GAS  
- G110 -  
25 KW - 85.300 BTU/H  
1/2" Inlet

Electric connection:  
0.5 Kw - 230 V - 1PH  
16 Amp



E-01

Water connection  
Drain water connection 1 1/4"  
Copper or SIS  
Kitchen waste / Fun dish  
34 Liters Consumption



W-02

Water connection  
Cold water connection  
for spray filter 1/2"



W-01

Exhaust connection:  
300x300 mm Universal flange  
450l/sec. @150Pa



Ex-01

Panel requirements:  
1x lower panel under oven  
- this must be ventilated -  
min. size 600x600 mm



P-02

Panel requirements:  
On upper right side,  
next to the spray filter  
min. size 600x600 mm

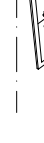

P-01

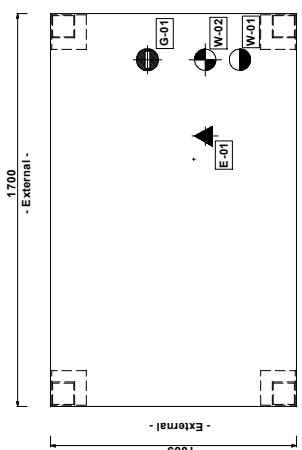
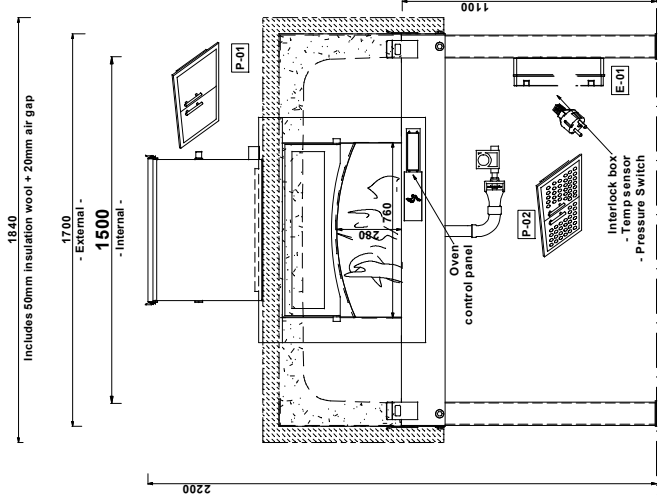
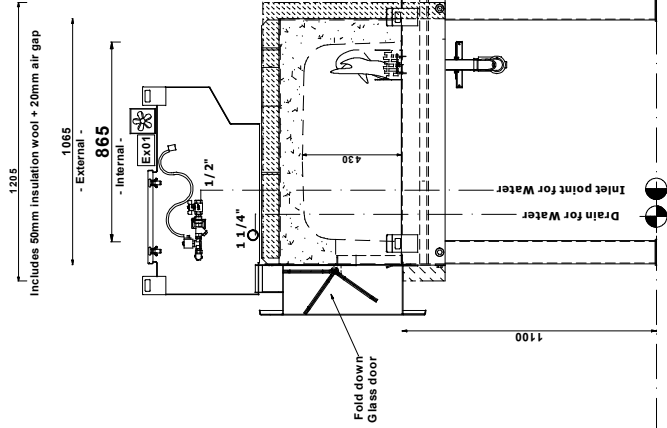

- Suggested M&E position -

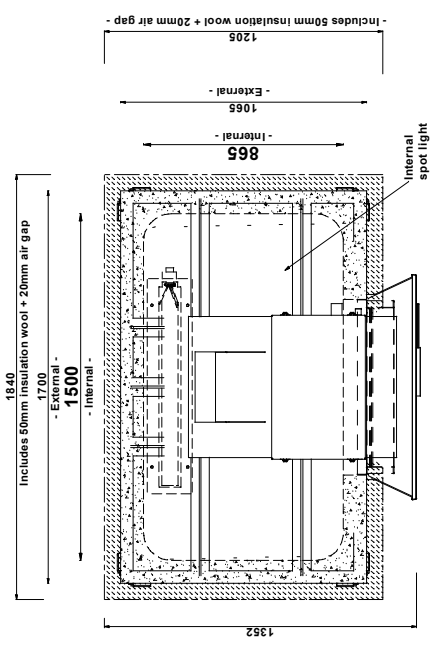

- Custom sizes available on request -

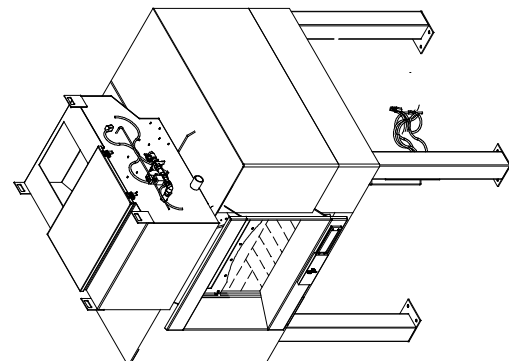

**- Services -**

NG - Natural Gas  
- G20/G25/G26.3 -  
3325 KW - 112.596/119420 BTU/H  
1/2" Inlet



LPG - G30/G31 -  
29/32 KW - 98.948/103.184 BTU/H  
1/2" Inlet

TOWN GAS  
6 KW - 85.300 BTU/H  
1/2" Inlet



Electric connection:  
0.5 Kw - 230 V - 1PH  
16 Amp



Exhaust connection:  
300x300 mm Universal flange  
450l/sec

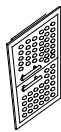

Panel requirements:  
1x lower panel under oven  
- this must be ventilated -  
min. size 600x600 mm

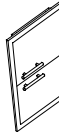

Panel requirements:  
On upper right side  
next to the spray filter  
min. size 600x600 mm

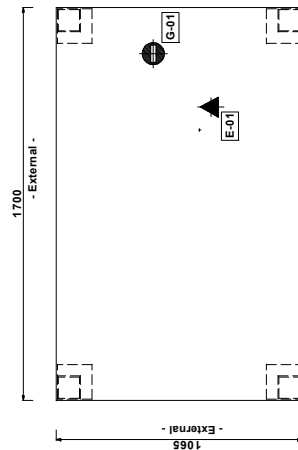
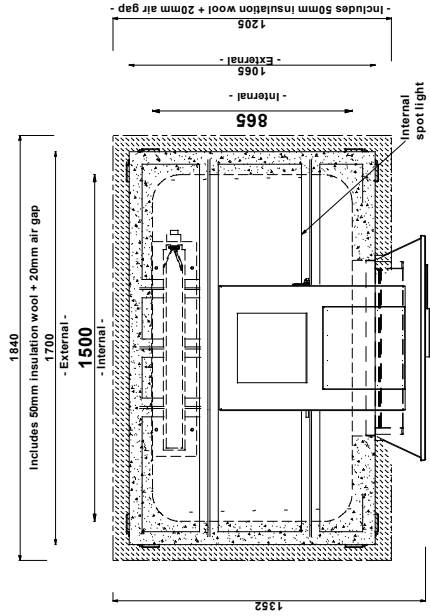
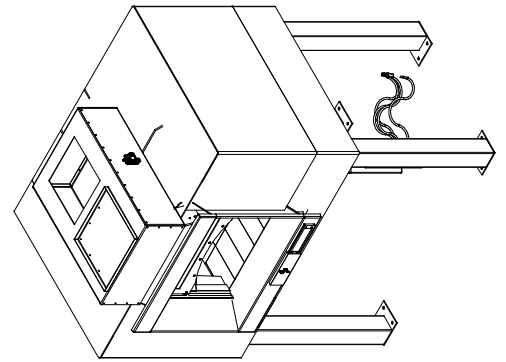
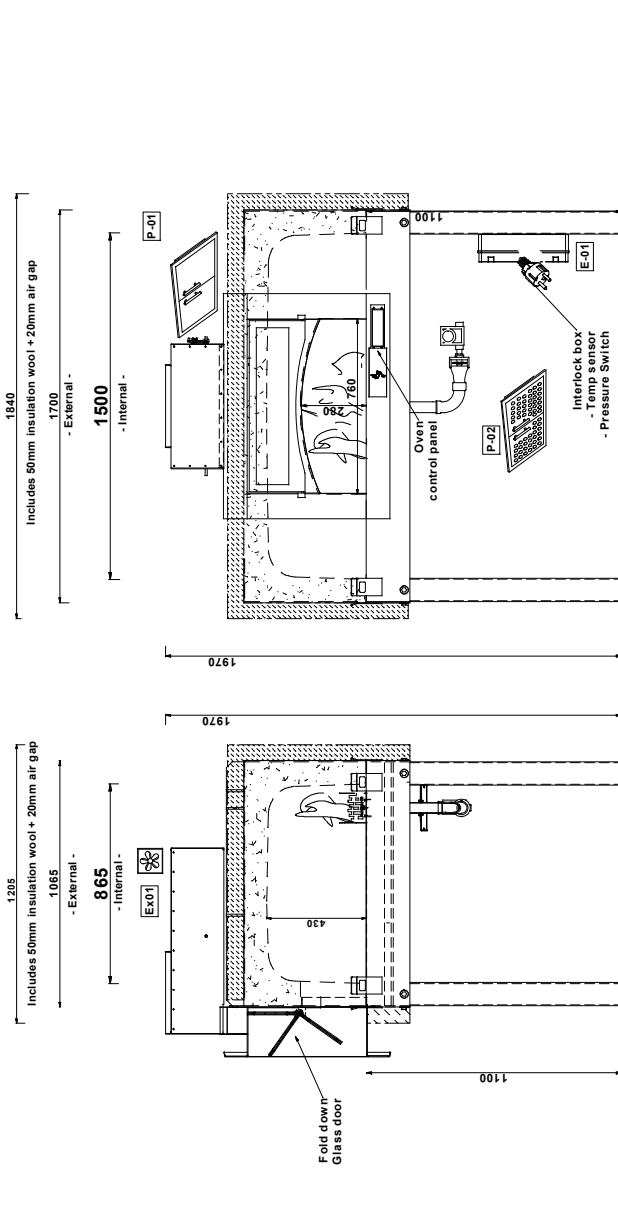

**- Suggested M&E position -**

**- Custom sizes available on request -**

**- Services -**

NG - Natural Gas  
- G20/G25/G25.3 -  
33/35 Kw - 112.596/19420 BTU/H  
1/2" Inlet



**G-01**

LPG  
- G30/G31 -  
29/32 Kw - 98.948/109.184 BTU/H  
1/2" Inlet

TOWN GAS  
- G110 -  
25 Kw - 85.300 BTU/H  
1/2" Inlet

Electric connection:  
0.5 Kw - 230 V - 1PH  
16 Amp



**E-01**

Exhaust connection:  
Canopy / Hood BY Others



**Ex-01**

Panel requirements:  
1x lower panel under oven  
- this must be ventilated -  
min. size 600x600 mm

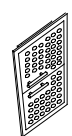

**P-02**

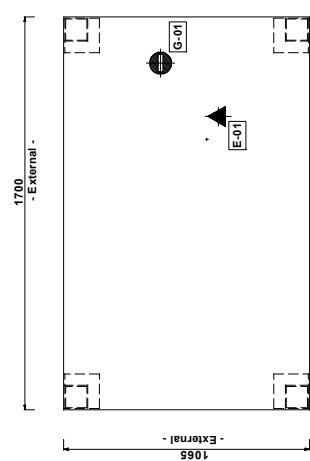
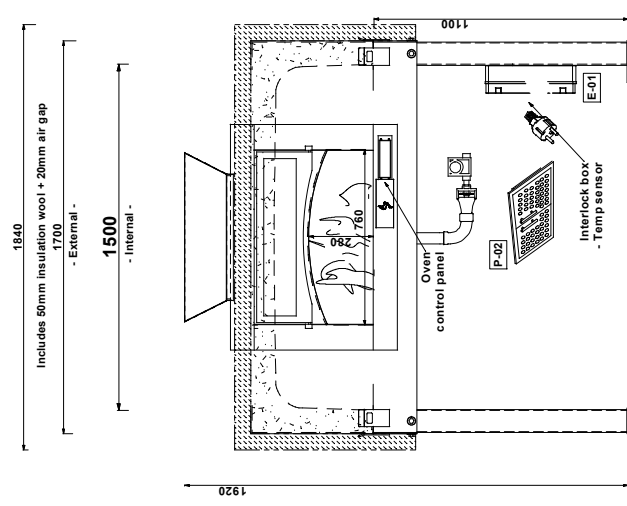
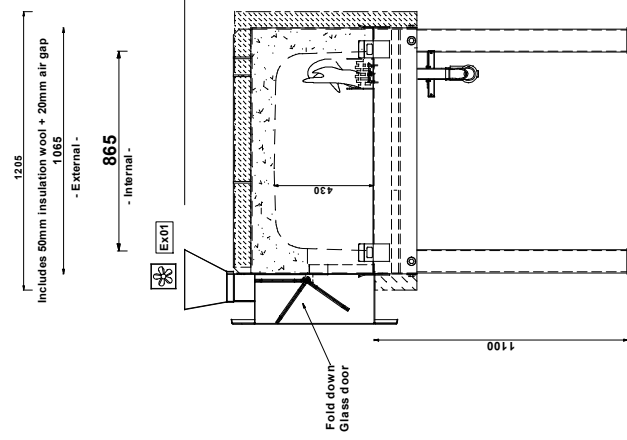



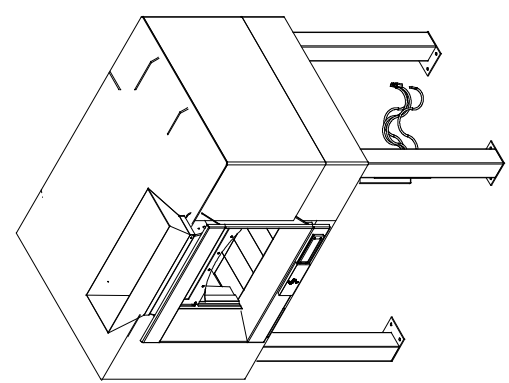
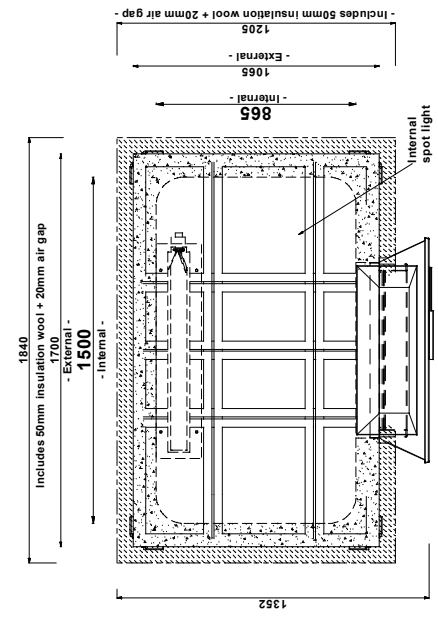

- Suggested M&E position -



- Custom sizes available on request -

- Services -

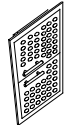
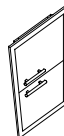
- E-01**  Electric connection:  
0.5 Kw - 230 V - 1PH  
16 Amp
- W-02**  Drain water connection 1 1/4"  
Copper or SIS  
Kitchen waste / Fun dish  
34 Litri - Consumption
- W-01**  Water connection  
Cold water connection  
for spray filter 1/2"
- Ex-01**  Exhaust connection:  
300x300 mm Universal flange  
450l/sec. @150Pa
- P-02**  Panel requirements:  
1x lower panel under oven  
- this must be ventilated -  
min. size 600x600 mm
- P-01**  Panel requirements:  
On upper right side  
next to the spray filter  
min. size 600x600 mm

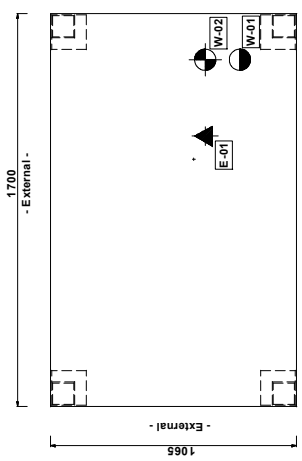
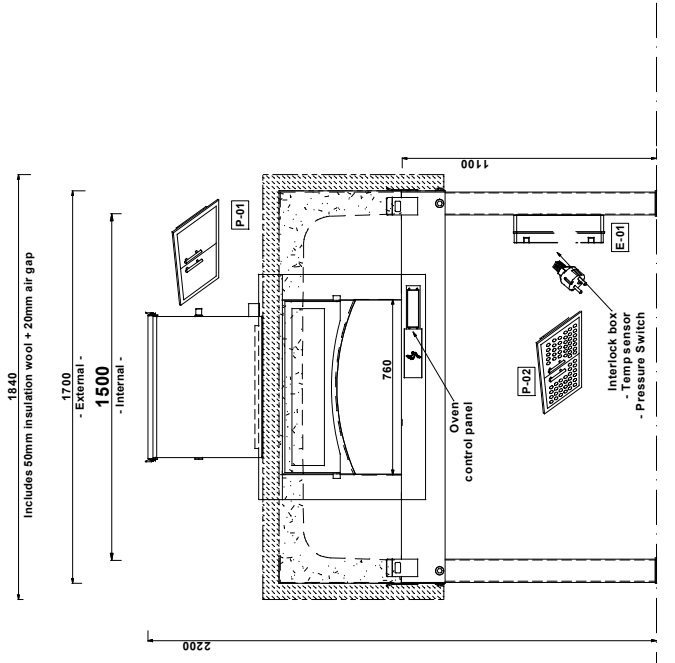
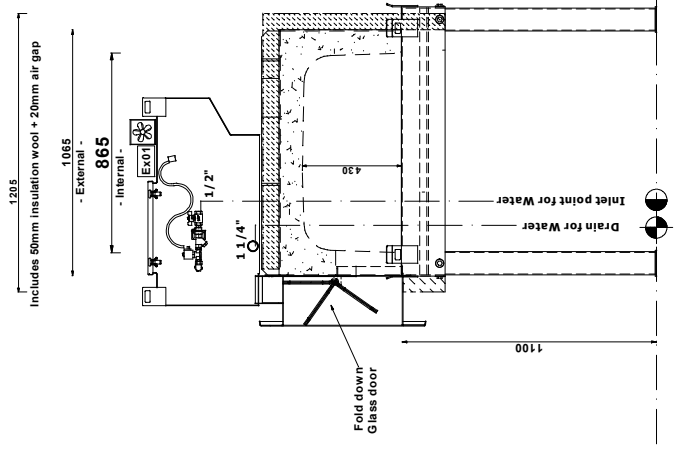

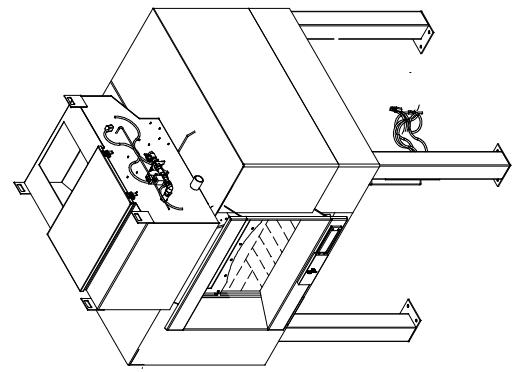
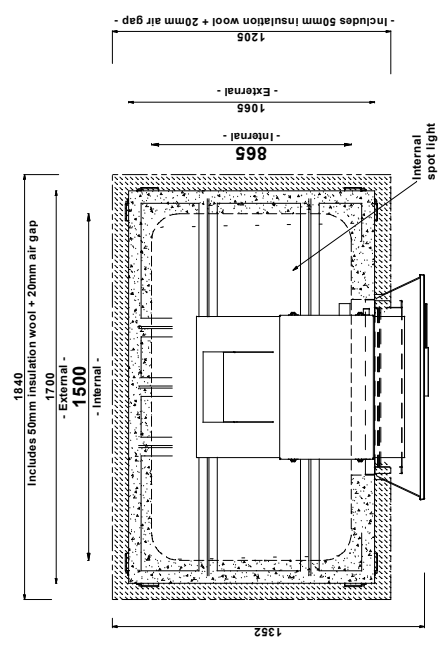

- Suggested M&E position -



- Custom sizes available on request -

**- Services -**

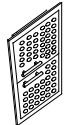
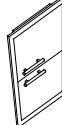
- E-01**  Electric connection:  
0.5 Kw - 230 V - 1PH  
16 Amp
- Ex.01**  Exhaust connection:  
300x300 mm Universal flange  
450l/sec
- P-02**  Panel requirements:  
1x lower panel under oven  
- this must be ventilated -  
min. size 600x600 mm
- P-01**  Panel requirements:  
On upper right side  
next to the spray filler  
min. size 600x600 mm

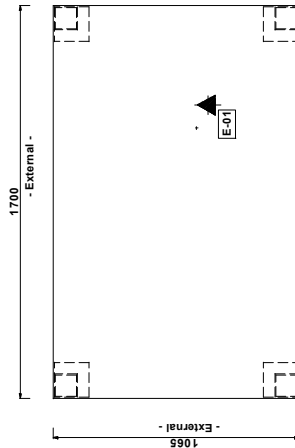
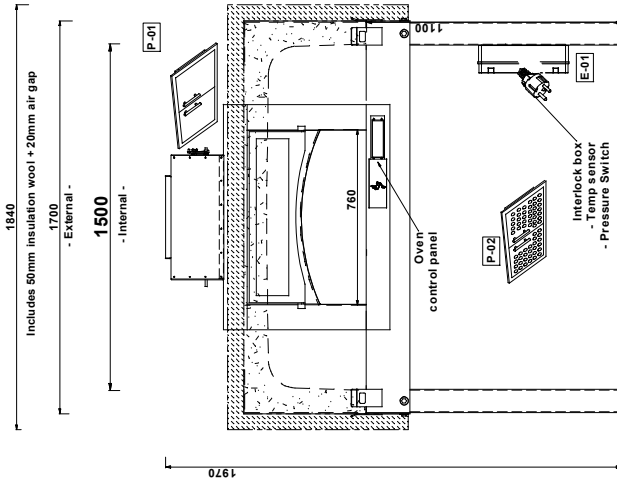
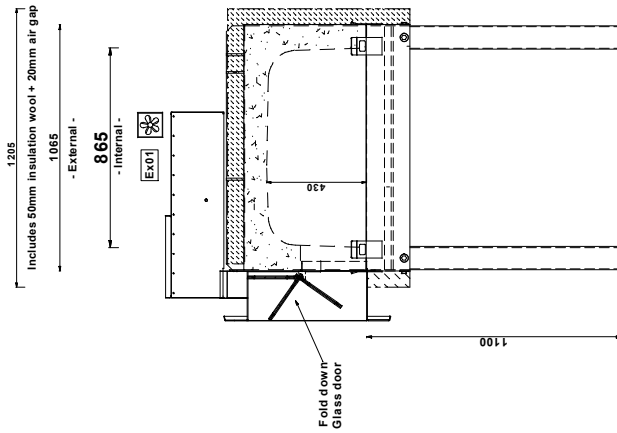

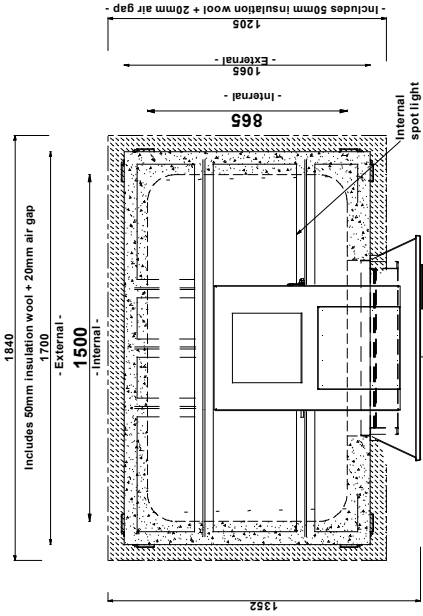

**- Suggested M&E position -**



**- Custom sizes available on request -**

**- Services -**

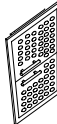
- E-01**  **Electric connection:**  
0.5 Kw - 230 V - 1PH  
16 Amp
- Ex-01**  **Exhaust connection:**  
Canopy / Hood BY Others
- P-02**  **Panel requirements:**  
1x lower panel under oven  
- this must be ventilated -  
min. size 600x800 mm

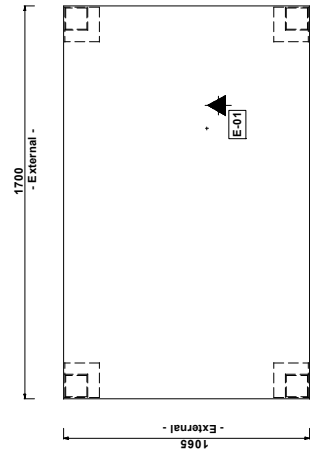
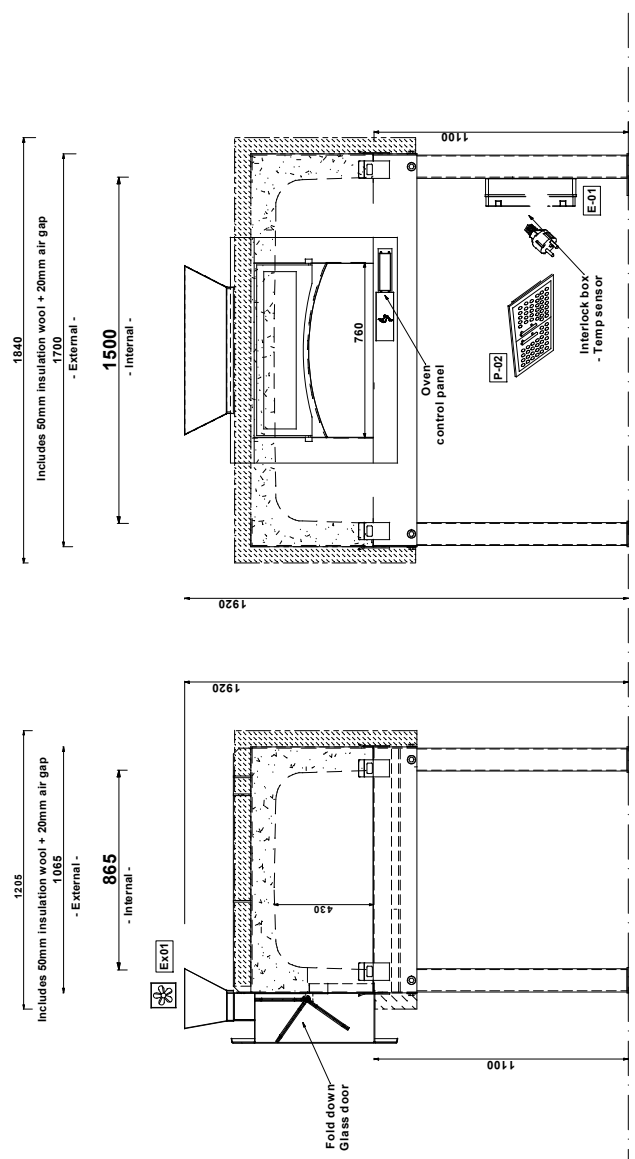

**- Suggested M&E position -**

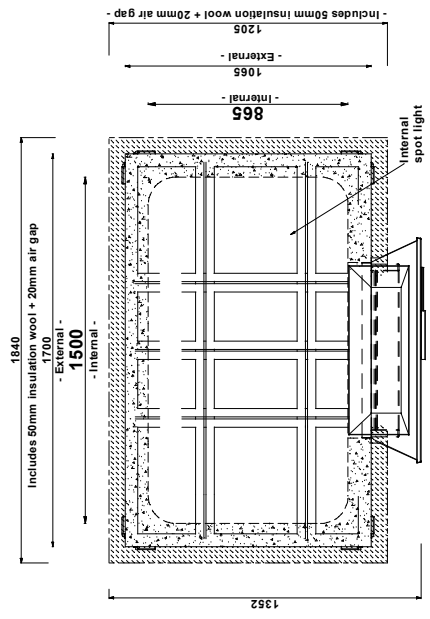



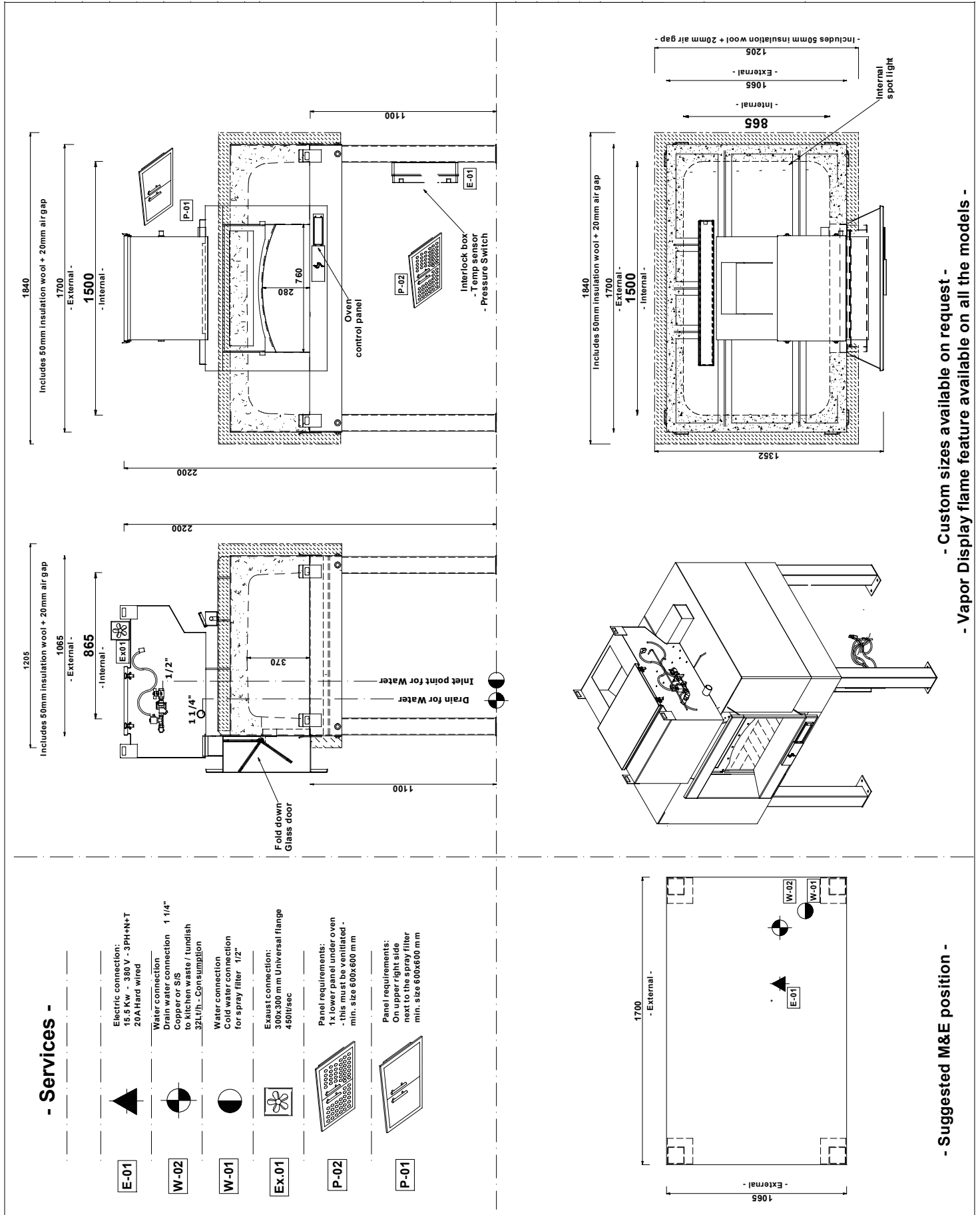

**- Custom sizes available on request -**



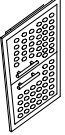

**- Services -**

- E-01**  Electric connection:  
15.5 Kw - 380 V - 3PH+N+T  
20A Hard wired
- Ex.01**  Exhaust connection:  
300x300 mm Universal flange  
450lit/sec
- P-02**  Panel requirements:  
1x lower panel under oven  
- this must be ventilated -  
min. size 600x600 mm
- P-01**  Panel requirements:  
On upper right side  
next to the spray filler  
min. size 600x600 mm

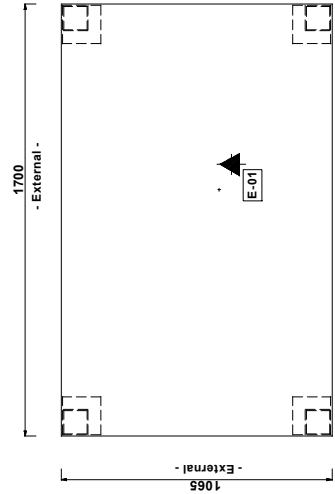
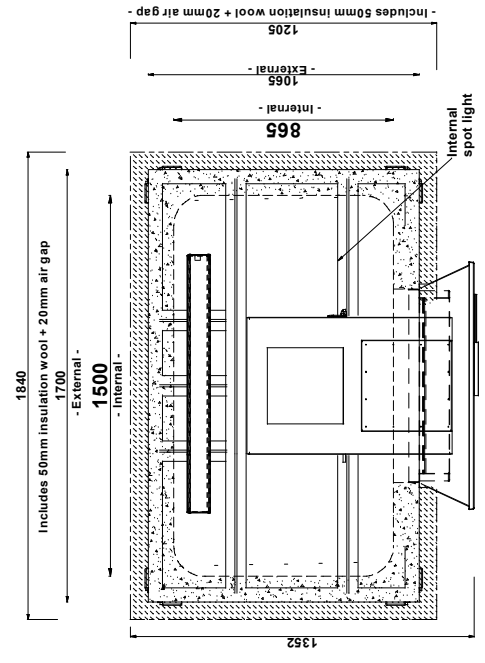
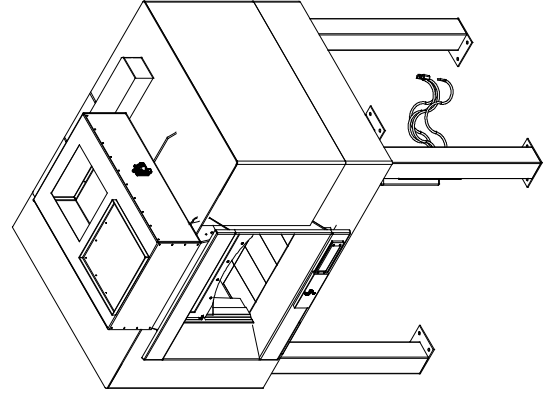
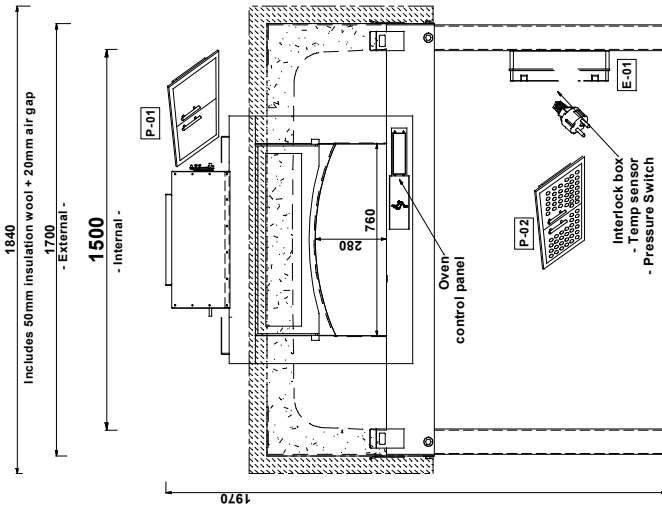
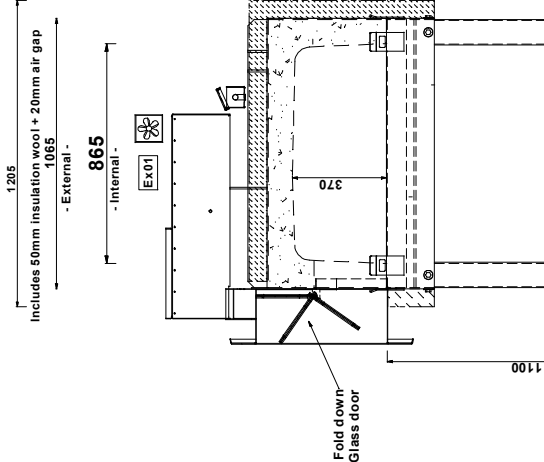

- Suggested M&E position -

- Custom sizes available on request -  
- Vapor Display flame feature available on all the models -

